

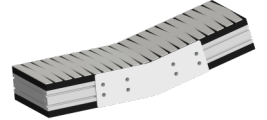

Qualität aus Liebe zum Detail

Scharnierbandförderer APSBK 130K-ASG



Name _____

Firma _____

Adresse _____

Telefon _____ Email _____

Anfragenummer _____

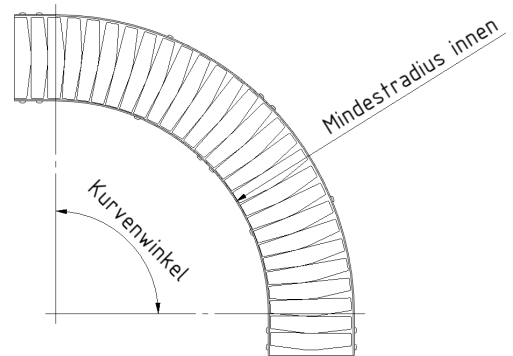
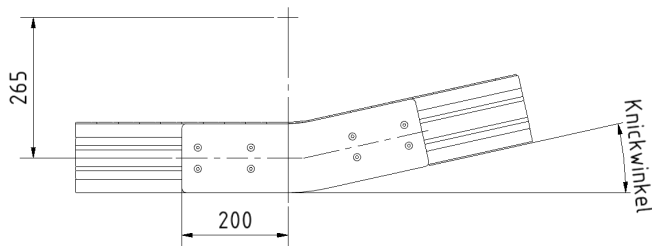
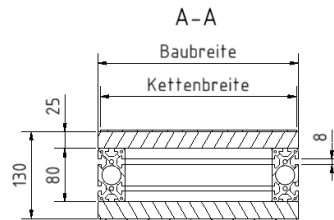
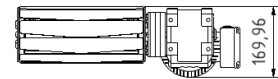
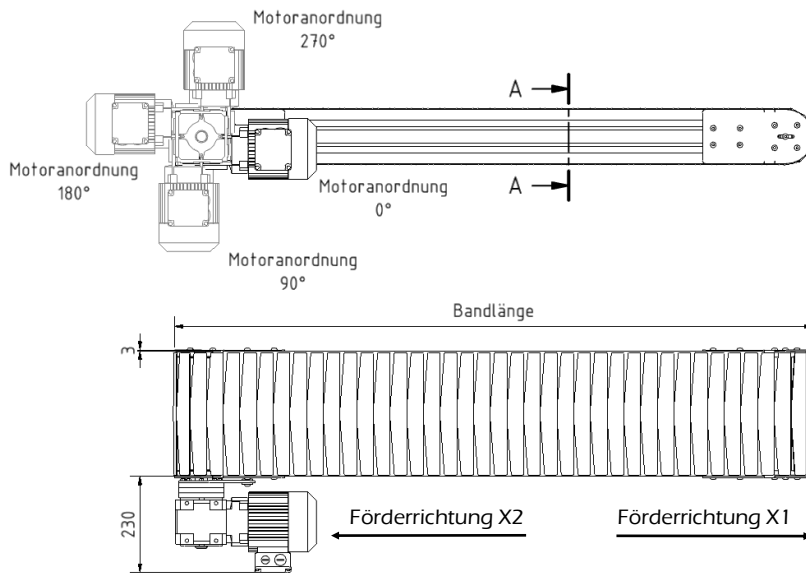



Qualität aus Liebe zum Detail

Scharnierbandförderer APSBK 130K-ASG

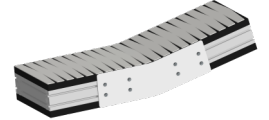

Förderband	
Gesamtbandlänge	<input type="text"/> mm
Kettenbreite	<input type="text"/> mm
Baubreite (Kettenbreite +6)	<input type="text"/> mm
Motoranordnung	<input type="text"/> °
Kettenausführung	<input type="text"/>
Stückgewicht	<input type="text"/> Kg
Gesamtbelastung	<input type="text"/> Kg
Fördergeschwindigkeit	<input type="text"/> m/min
Förderrichtung	<input type="text"/>

Betriebsart	
Stetigbetrieb	<input type="checkbox"/>
Taktbetrieb	<input type="checkbox"/>
Staubetrieb	<input type="checkbox"/>

Förderstecke	
L1	<input type="text"/> mm
Knick (°) / Kurve (r-l°)	<input type="text"/> <input type="text"/> °
L2	<input type="text"/> mm
Knick (°) / Kurve (r-l°)	<input type="text"/> <input type="text"/> °
L3	<input type="text"/> mm
Knick (°) / Kurve (r-l°)	<input type="text"/> <input type="text"/> °
L4	<input type="text"/> mm

Antriebsmotor	
Spannung	<input type="text"/> V
Frequenz	<input type="text"/> Hz

Motoranordnung	
Motor links schiebend	<input type="checkbox"/>
Motor rechts schiebend	<input type="checkbox"/>
Motor links ziehend	<input type="checkbox"/>
Motor rechts ziehend	<input type="checkbox"/>

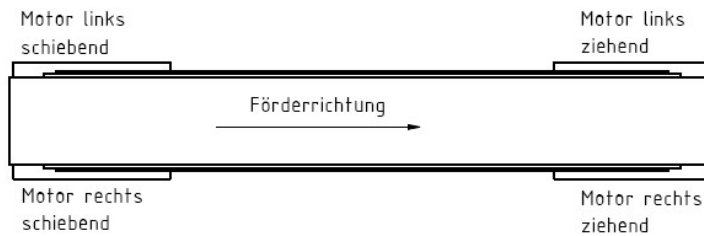

Notizen