

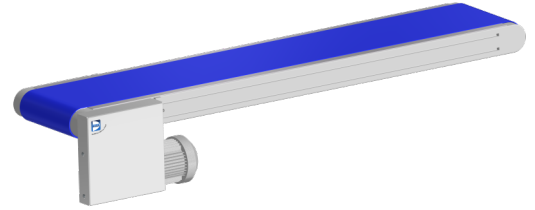

Qualität aus Liebe zum Detail

Gurtförderer APB80K



Name _____

Firma _____

Adresse _____

Telefon _____ Email _____

Anfragenummer _____

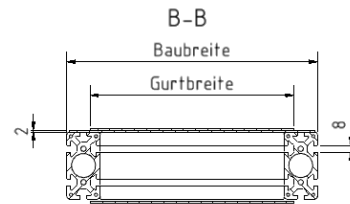
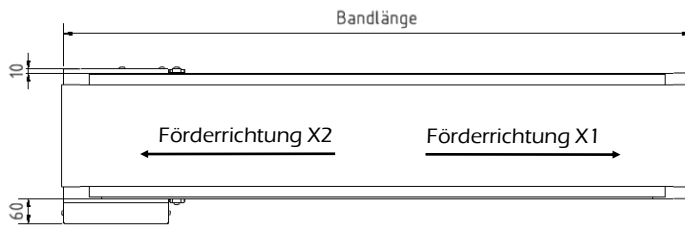
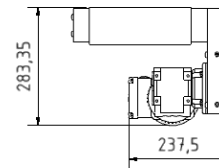
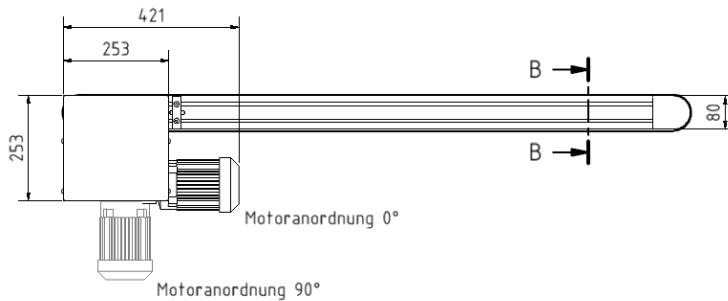

Förderband	
Bandlänge	<input type="text"/> mm
Gurtbreite	<input type="text"/> mm
Baubreite (Gurtbreite +56)	<input type="text"/> mm
Motoranordnung	<input type="text"/> °
Gurtausführung	<input type="text"/>
Stückgewicht	<input type="text"/> Kg
Gesamtbelastung	<input type="text"/> Kg
Fördergeschwindigkeit	<input type="text"/> m/min
Förderrichtung	<input type="text"/>

Betriebsart	
Stetigbetrieb	<input type="checkbox"/>
Taktbetrieb	<input type="checkbox"/>
Staubetrieb	<input type="checkbox"/>



Qualität aus Liebe zum Detail

Gurtförderer APB80K

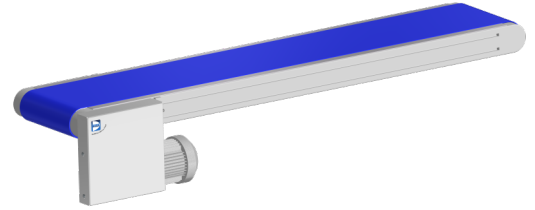

Antriebsmotor	
Spannung	<input type="text"/> V
Frequenz	<input type="text"/> Hz

Motoranordnung	
Motor links schiebend	<input type="checkbox"/>
Motor rechts schiebend	<input type="checkbox"/>
Motor links ziehend	<input type="checkbox"/>
Motor rechts ziehend	<input type="checkbox"/>

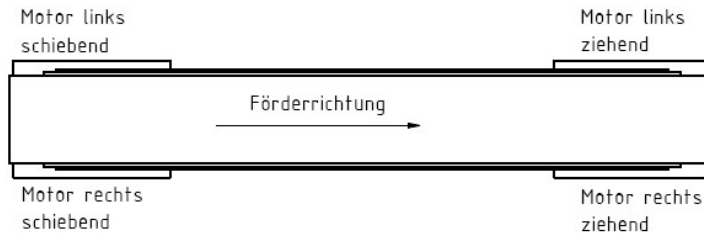

Notizen