

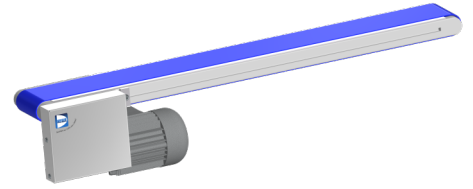

Qualität aus Liebe zum Detail

# Gurtförderer APB40K



Name \_\_\_\_\_

Firma \_\_\_\_\_

Adresse \_\_\_\_\_

\_\_\_\_\_

Telefon \_\_\_\_\_ Email \_\_\_\_\_

Anfragenummer \_\_\_\_\_

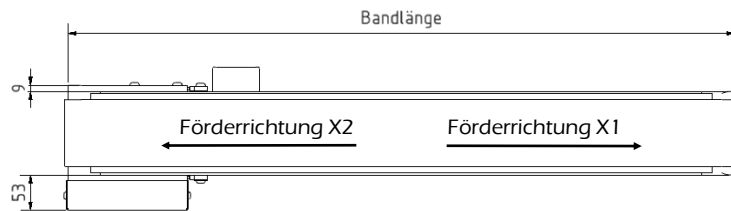
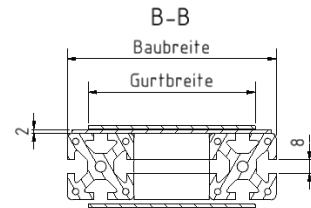
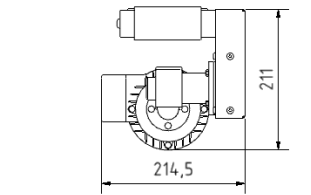
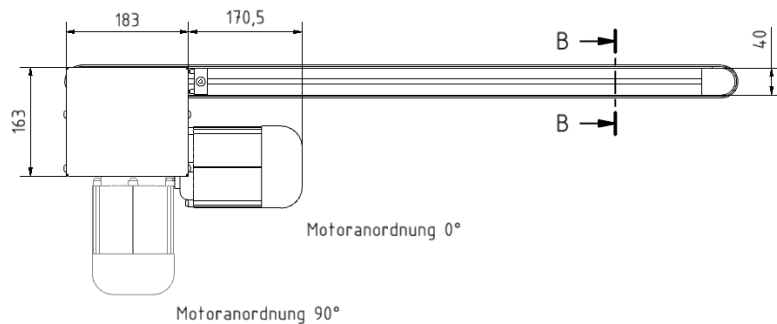

Förderband	
Bandlänge	<input type="text"/> mm
Gurtbreite	<input type="text"/> mm
Baubreite (Gurtbreite +25)	<input type="text"/> mm
Motoranordnung	<input type="text"/> °
Gurtausführung	<input type="text"/>
Stückgewicht	<input type="text"/> Kg
Gesamtbelastung	<input type="text"/> Kg
Fördergeschwindigkeit	<input type="text"/> m/min
Förderrichtung	<input type="text"/>

Betriebsart	
Stetigbetrieb	<input type="checkbox"/>
Taktbetrieb	<input type="checkbox"/>
Staubbetrieb	<input type="checkbox"/>



Qualität aus Liebe zum Detail

## Gurtförderer APB40K

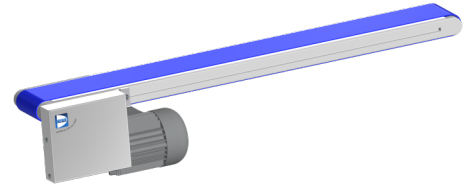

### Antriebsmotor

Spannung  V

Frequenz  Hz

### Motoranordnung

Motor links schiebend

Motor rechts schiebend

Motor links ziehend

Motor rechts ziehend

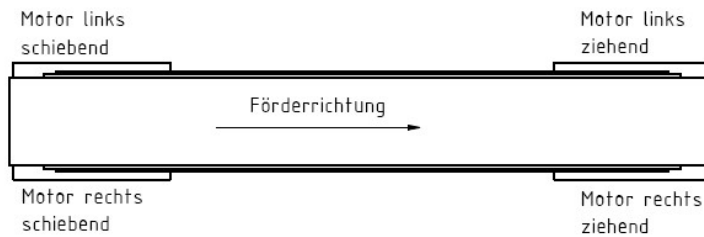

## Notizen